



§ **SPECIFICATION APPROVAL SHEET** §

Fdt Tech Module No	LP043A7IBX-FXR
Description:	4.3" Digital TFT-LCD Module
SPEC No.:	SAS-1012003
Version:	0.0
Issue Date:	December 15, 2010

※ This approval sheet contains 22 pages including the cover and appendix.

Customer:	APPROVED BY:
Date: / / 10	

APPROVED BY:

CHECKED BY:

DESIGNED BY:



FLAT DISPLAY TECHNOLOGY

4.3" Digital TFT-LCD Module

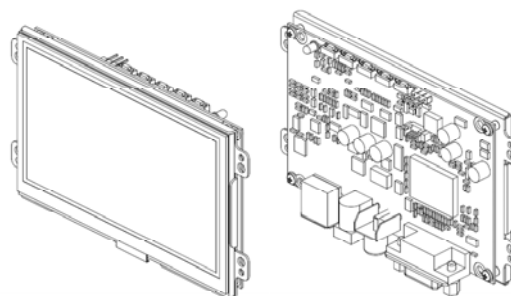

■ LP043A7IB~~x~~-F~~x~~R

1. General Descriptions

1.1 Features

- CMI AT043TN24 V7 Digital TFT LCD
- Ultra Compact
- NTSC/PAL/SECAM Video Auto Switch
- Single Operation Voltage +12V
- CVBS / Analog RGB (PC Mode) Signal Input
- All Functions can be controlled by UART
- Support Touch Screen Function

1.2 Applications

- Portable product
- Industrial
- Hand-held
- Security
- Instrument Display
- Office Electronics

1.3 Application Precautions

Do not use the products herein for the following equipment which demands extremely high performance in terms of functionality, reliability, or accuracy.

- Aerospace equipment
- Communication equipment for trunk lines.
- Control equipment for the nuclear power industry.
- Medical equipment related to life support, etc.

The other application that demands high reliability and functionality should first contact a sales representative.

FLAT DISPLAY TECHNOLOGY

■ LP043A7IB~~x~~-F~~x~~R V0.0



2. Contents

Contents	Page
1. General Description	1
1.1 Features	1
1.2 Applications	1
1.3 Application Precautions	1
2. Contents	2-3
3. Block Diagram	4
3.1 Block Diagram	4
4. TFT-LCD Information	5
4.1 TFT-LCD Mechanical Specifications	5
4.2 TFT-LCD Optical Characteristics	5
5. Order Information	6
5.1 Unit	6
6. Dimension Information	7-8
6.1 Unit (LP043A7IB4-FNR)	7
6.2 Unit (LP043A7IB5-FNR)	8
7. Pin Description	9-12
7.1 J301 : CMI Panel I/O Terminals (FPC 40 Pin Pitch 0.5mm UP Contact Type)	9-10
7.2 J101B : Pin Assignment of Analog RGB Input (D-Sub 15Pin)	10
7.3 J104: Pin Assignment of UART (Pitch 1.25mm 4Pin, Top Entry Type)	11
7.4 DC JACK: Pin Assignment of Power Input (Inside Diameter:2.1 ψ Outside Diameter:5.5 ψ Side Entry Type)	11
7.5 RCA: Pin Assignment of Video Input (RCA JACK Yellow, Side Entry Type)	11
7.6 J401E : Pin Assignment of Touch USB (USBA-Female 2.0mm, Side Entry Type)(Option)	11
7.7 J401D : Pin Assignment of Touch RS232 (D-SUB 9 FEMALE)(Option)	12
8. Absolute Maximum Ratings	12
8.1 Absolute Maximum Ratings	12
9. Recommended Operating Conditions	13
9.1 Electrical Characteristics	13
9.2 VGA Mode Characteristics	13
9.3 Panel Backlight Data	13
9.4 Optics Sample Test Data	13
10. 4W Resistance Touch Panel Characteristics	14-15
10.1 Pin assignment	14
10.2 Electrical Performance	14
10.3 Mechanical Performance	14
10.4 Durability Performance	14
10.5 Touch Screen Integration Design Guide	15
11. Operation Manual	16

11.1 Driver Board Manual	16
<i>12. Packing List</i>	17
<i>13. Key Function by OSD</i>	18-21
13.1 Menu Operation	18-20
13.2 Operations	21

Tentative

3. Block Diagram

3.1 Block Diagram

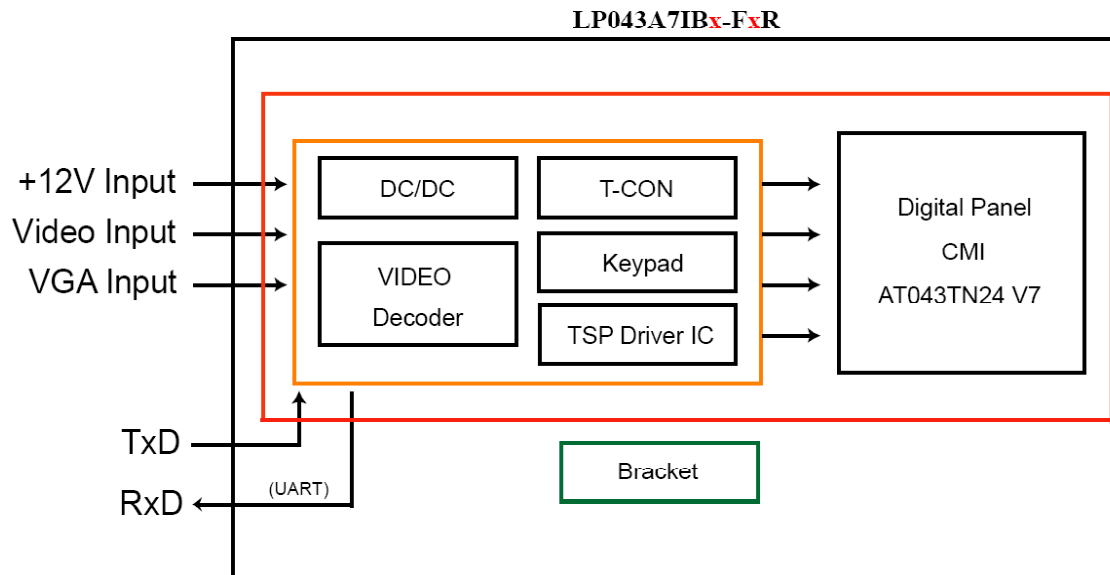

Tent

4. TFT-LCD Information

4.1 TFT-LCD Mechanical Specifications

Parameter	Specifications	Unit
Screen Size	4.3 (diagonal)	inch
Display Format	480 x (R.G.B) x 272	dot
Active Area	95.04(W) x 53.856(H)	mm
Pixel Pitch	0.198(W) x 0.198(H)	mm
Pixel Configuration	Stripe	
Outline Dimension	105.5(W) x 67.2(H) x 4.05(D)	mm
Surface Treatment	Anti – Glare	

4.2 TFT-LCD Optical Characteristics

Parameter	Symbol	Condition	Min	Typ	Max	Unit	Remark	
Viewing Angle	Horizontal	Left	60	70	---	deg		
		Right	60	70	---	deg		
	Vertical	Top	CR >10	40	50	---	deg	
		Bottom		60	70	---	deg	
Contrast Ratio	CR	$\theta = 0^\circ$	400	500	---	---		
Response time	Rise Fall	Tr	---	10	20	ms		
		Tf	$\theta = 0^\circ$	---	15	30	ms	
Uniformity	U	$\theta = 0^\circ$	70	75	---	%		
Brightness	L	$\theta = 0^\circ$	350	400	---	Cd/m ²		
White Chromaticity	x	$\theta = 0^\circ$	0.26	0.31	0.36			
	y	$\theta = 0^\circ$	0.28	0.33	0.38			
LED Life Time		+25°	20000	---	---	Hrs		

FLAT DISPLAY TECHNOLOGY

■ LP043A7IBx-FxR V0.0



5. Order Information

5.1 Unit

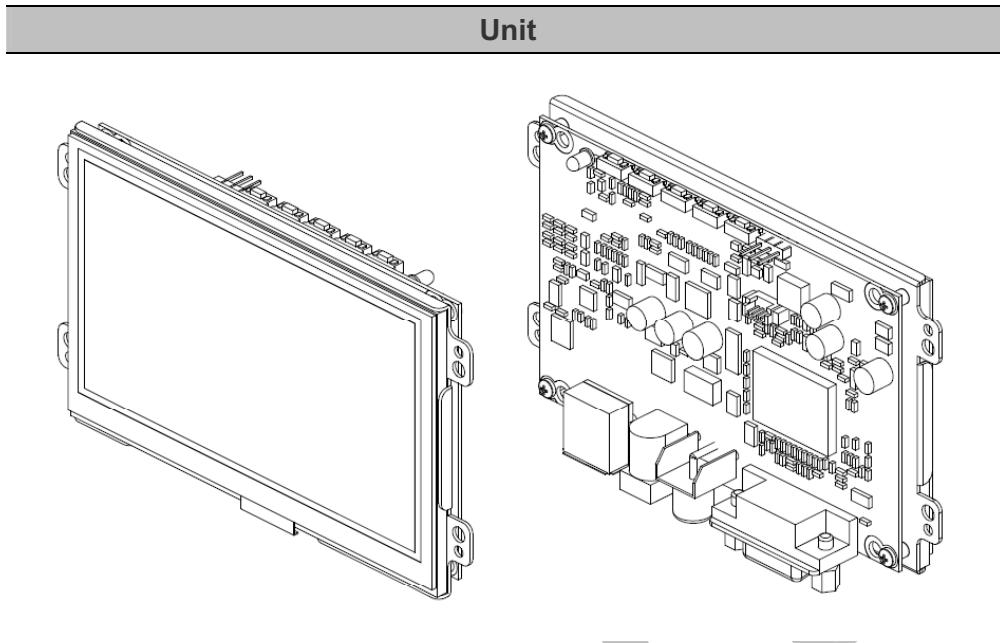

Parameter	LP043A7IB4-FBR	LP043A7IB5-FBR	LP043A7IB4-FNR	LP043A7IB5-FNR	Unit
CVBS	1	1	1	1	
VGA (D-Sub15 / 2.0mm 14Pin)	D-Sub15	D-Sub15	D-Sub15	D-Sub15	
Touch Panel Type	4W Resistive	4W Resistive	4W Resistive	4W Resistive	
Touch Screen Interface	USB	RS232	USB	RS232	
AC to DC Adapter 12V/2.5A (LASTD12025-FDR)	⊙	⊙	-	-	
Power Cord Plug Type B for USA (LAAC818000-FDR)	⊙	⊙	-	-	
Video Cable (LAVDO18000-FDR)	⊙	⊙	-	-	
VGA Cable (LAVGA16000-FDR)	⊙	⊙	-	-	
USB Cable (LAUSB18000-FDR)	⊙	-	-	-	
RS-232 Cable (LARS218000-FDR)	-	⊙	-	-	
Touch Screen Driver CD Disk	⊙	⊙	⊙	⊙	

FLAT DISPLAY TECHNOLOGY

■ LP043A7IB~~x~~-F~~x~~R V0.0



6. Dimension Information

6.1 Unit (LP043A7IB4-FNR)

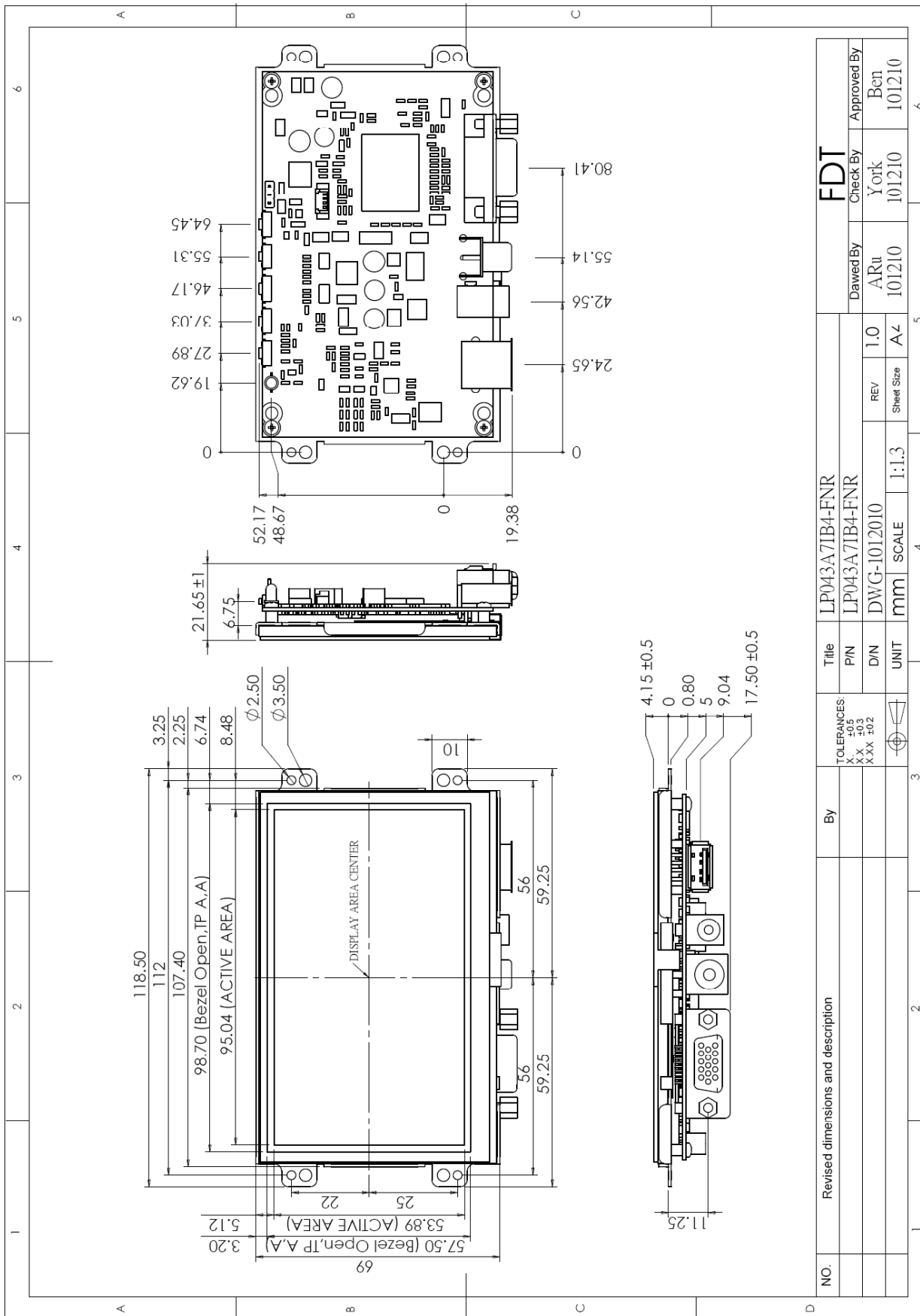

FLAT DISPLAY TECHNOLOGY

■ LP043A7IBx-FxR V0.0 

6.2 Unit (LP043A7IB5-FNR)

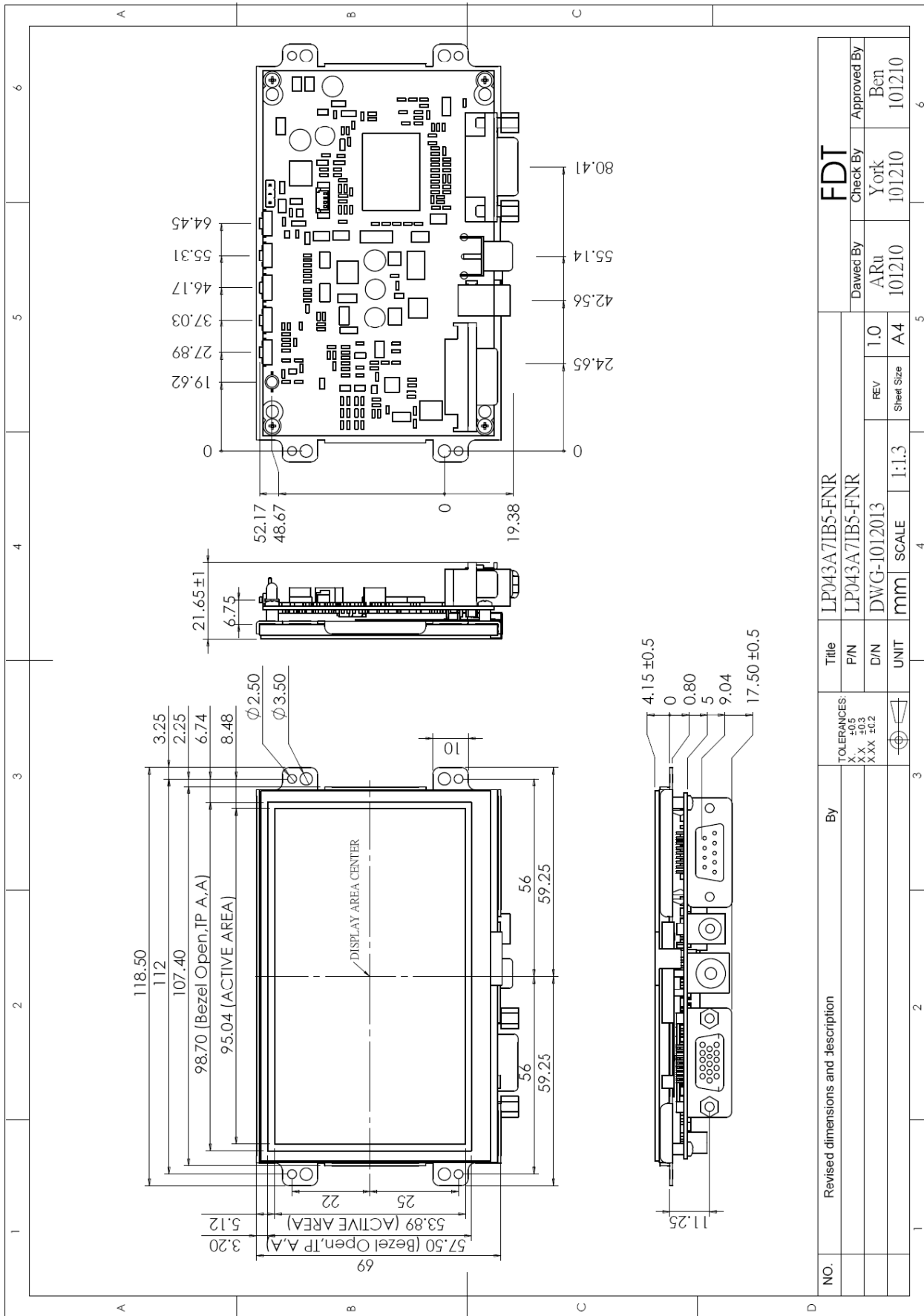

FLAT DISPLAY TECHNOLOGY

■ LP043A7IBx-FxR V0.0



7. Pin Description

7.1 J301 : CMI Panel I/O Terminals (FPC 40 Pin Pitch 0.5mm UP Contact Type)

Pin No	Symbol	I/O	Description	Remark
1	VLED-	P	Power for LED backlight cathode	
2	VLED+	P	Power for LED backlight anode	
3	GND	P	Power ground	
4	VDD	P	Power voltage	
5	R0	I	Red data (LSB)	
6	R1	I	Red data	
7	R2	I	Red data	
8	R3	I	Red data	
9	R4	I	Red data	
10	R5	I	Red data	
11	R6	I	Red data	
12	R7	I	Red data (MSB)	
13	G0	I	Green data (LSB)	
14	G1	I	Green data	
15	G2	I	Green data	
16	G3	I	Green data	
17	G4	I	Green data	
18	G5	I	Green data	
19	G6	I	Green data	
20	G7	I	Green data (MSB)	
21	B0	I	Blue data (LSB)	
22	B1	I	Blue data	
23	B2	I	Blue data	
24	B3	I	Blue data	
25	B4	I	Blue data	
26	B5	I	Blue data	
27	B6	I	Blue data	
28	B7	I	Blue data (MSB)	
29	GND	P	Power ground	
30	CLK	I	Pixel clock	
31	DISP	I	Display on/off	
32	NC	-	No connection	
33	NC	-	No connection	
34	DE	I	Data Enable	
35	NC	-	No connection	
36	GND	P	Power ground	
37	X1	I/O	Right electrode – differential analog	

FLAT DISPLAY TECHNOLOGY

■ LP043A7IB_x-F_xR V0.0



38	Y1	I/O	Bottom electrode – differential analog
39	X2	I/O	Left electrode – differential analog
40	Y2	I/O	Top electrode – differential analog

7.2 J101B : Pin Assignment of Analog RGB Input (D-Sub 15Pin)

Pin No	Symbol	I/O	Description	Remark
1	RI+	I	Analog Red Signal	
2	GI+	I	Analog Green Signal	
3	BI+	I	Analog Blue Signal	
4	NC	-	No Connection	
5	GND	-	Ground	
6	AGND	-	Analog Ground	
7	AGND	-	Analog Ground	
8	AGND	-	Analog Ground	
9	VGA5V	-	VGA +5V Input	
10	VGA-Det	I	VGA Detect	
11	NC	-	No Connection	
12	NC	-	No Connection	
13	HS_IN	I	TTL Horizontal sync	
14	VS_IN	I	TTL Vertical sync	
15	N.C	-	No Connection	

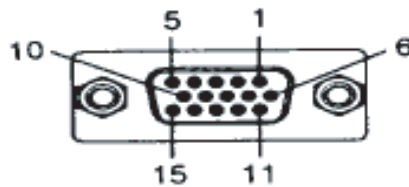

7.3 J104: Pin Assignment of UART (Pitch 1.25mm 4Pin, Top Entry Type)

※ Connector Part No.: 53398-0471 (MOLEX) or MS24014 (STM); Matching Connector Part No.: 51021-0400 (MOLEX) or P24014 (STM)

Pin No	Symbol	I/O	Description	Remark
1	TX	O	UART Transmission Data	
2	RX	I	UART Receive Data	
3	GND	-	Ground	
4	+3.3VA	O	+3.3V Output Voltage	

Note: All Functions can be controlled by UART , About UART command list please contact FDT sales.

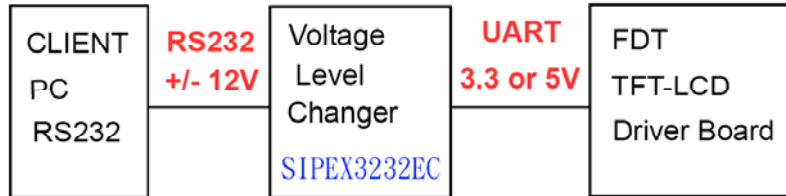

7.4 DC JACK: Pin Assignment of Power Input (Inside Diameter:2.1 ϕ Outside Diameter:5.5 ϕ Side Entry Type)

Pin No	Symbol	I/O	Description	Remark
1	VIN	I	+12V Input Voltage	
2	GND	-	Power Ground	

7.5 RCA: Pin Assignment of Video Input (RCA JACK Yellow, Side Entry Type)

Pin No	Symbol	I/O	Description	Remark
1	Video	I	Video Input	
2	AGND	-	Analog Ground	

7.6 J401E : Pin Assignment of Touch USB (USBA-Female 2.0mm, Side Entry Type)(Option)

Pin No	Symbol	I/O	Description	Remark
1	DGND	-	Digital Ground	
2	D+	-	DATA (+)	
3	D-	-	DATA (-)	
4	VBUS	-	USB VCC	

7.7 J401D : Pin Assignment of Touch RS232 (D-SUB 9 FEMALE)(Option)

Pin No	Symbol	I/O	Description	Remark
1	NC	-	No Connection	
2	TXD	-	Transmit Data	
3	RXD	-	Receive Data	
4	NC	-	No Connection	
5	GND	-	Ground	
6	NC	-	No Connection	
7	NC	-	No Connection	
8	NC	-	No Connection	
9	NC	-	No Connection	

8. Absolute Maximum Ratings

8.1 Absolute Maximum Ratings

Parameter	Symbol	Min	Max	Unit	Remark
Input Voltage	V _{in}	9	15	V	
Video Input Signal	Video in	0.5	2.0	V _{p-p}	@75Ω
Analog RGB Input Signal	Analog RGB in	0.5	2.0	V _{p-p}	@75Ω
Digital Input Signal	TTL	+0.3	+3.6	V	
Operating Temperature		-20	+70	°C	
Storage Temperature		-20	+70	°C	

FLAT DISPLAY TECHNOLOGY

■ LP043A7IB_x-F_xR V0.0



9. Recommended Operating Conditions

9.1 Electrical Characteristics

Parameter	Symbol	I/O	Min	Typ	Max	Unit	Note
Input Voltage	Vin	I	+10	+12	+14	V	
Total Current	Iin	I		-		mA	
Power Consumption		I		-		W	@+12V
Output Voltage	VDD	O	+3.2	+3.3	+3.4	V	I=10mA
Video Input Signal	Video in	I		1.0		Vp-p	@75Ω
Analog RGB Input Signal	Analog RGB in	RGB		0.7		Vp-p	@75Ω

9.2 VGA Mode Characteristics

Dots per inch	H	Unit	Polarity	V	Unit	Polarity	Note
640*480	31.469	KHz	Negative	59.941	Hz	Negative	
800*600	37.879	KHz	Positive	60.317	Hz	Positive	
1024*768	48.363	KHz	Negative	60.004	Hz	Negative	

9.3 Panel Backlight Data

Parameter	Symbol	Min	Typ	Max	Unit	Note
LED Backlight Voltage	VLED	25.2	27.9	31.5	Vrms	
LED Backlight Current	ILED	18	20	22	mA	

9.4 Optics Sample Test Data

Parameter	White Window	Red	Green	Blue	Remark
S/N : 001 x	-	-	-	-	
.y	-	-	-	-	±15%
L(cd/m ²)	-	-	-	-	
TC(°K)	-	-	-	-	

Note: 1. Luminance Meter : BM-7 FAST(TOPCON)

2.Video Pattern Generator: FLUKE PM54200

3. Measurement Distance : 500mm±50mm

4. TOPCON BM-7 Luminance Meter 2° filed of view is used in the testing

(After 10min ~20min operation)

FLAT DISPLAY TECHNOLOGY

■ LP043A7IBx-FxR V0.0



10. 4W Resistance Touch Panel Characteristics

10.1 Pin assignment

Pin No	Symbol	Description	Remark
1	X1	Right electrode – differential analog	
2	Y1	Bottom electrode – differential analog	
3	X2	Left electrode – differential analog	
4	Y2	Top electrode – differential analog	

10.2 Electrical Performance

Parameter	Symbol	Min	Typ	Max	Unit	Remark
Terminal Resistance	X	300		1500	Ω	
	Y	100		900	Ω	
Linearity		-1.5	-	1.5	%	
Insulation Impedance		25	-	-	MΩ	DC 25V
Response Time		-	-	10	ms	

10.3 Mechanical Performance

Parameter	Specifications
Input Method	Finger or stylus pen
Operating Force	80g Min.
Surface Hardness	3H or more

10.4 Durability Performance

Parameter	Specifications
Hitting Durability	≥ 1000000 times, with R8.0 mm silicon rubber, 200g, 2 times/sec
Sliding Durability	≥ 100000 words, with R0.8 mm polyacetal stylus, 250g, 60 mm/sec

10.5 Touch Screen Integration Design Guide

Avoid the design that Front-case overlap and press on the active area of the touch-panel.

Give enough gap (over 0.5mm at compressed) between the front case and touch-panel to protect wrong operating.

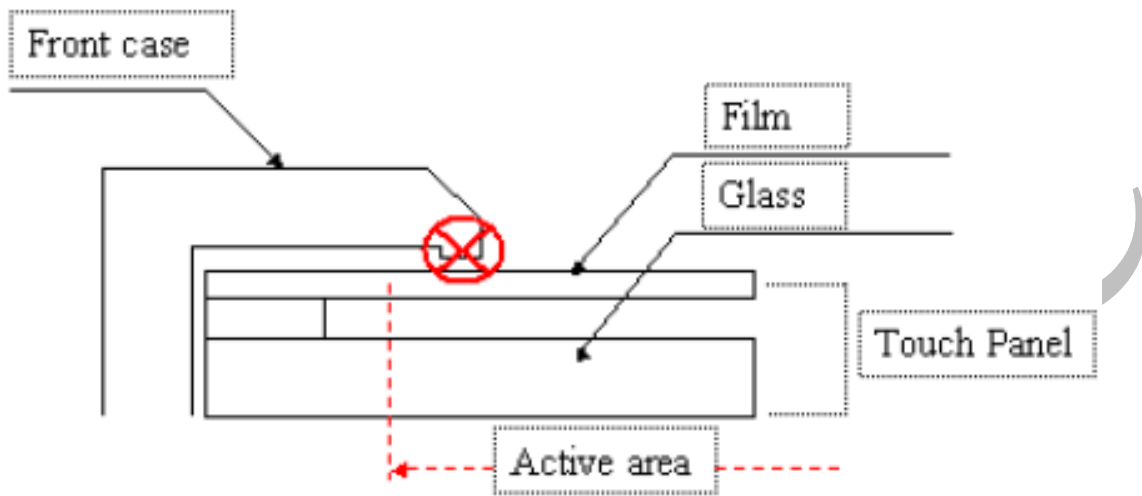

Use a buffer material (Gasket) between the touch-panel and front-case to protect damage and wrong operating.

Avoid the design that buffer material overlap and press on the inside of touch-panel viewing area.

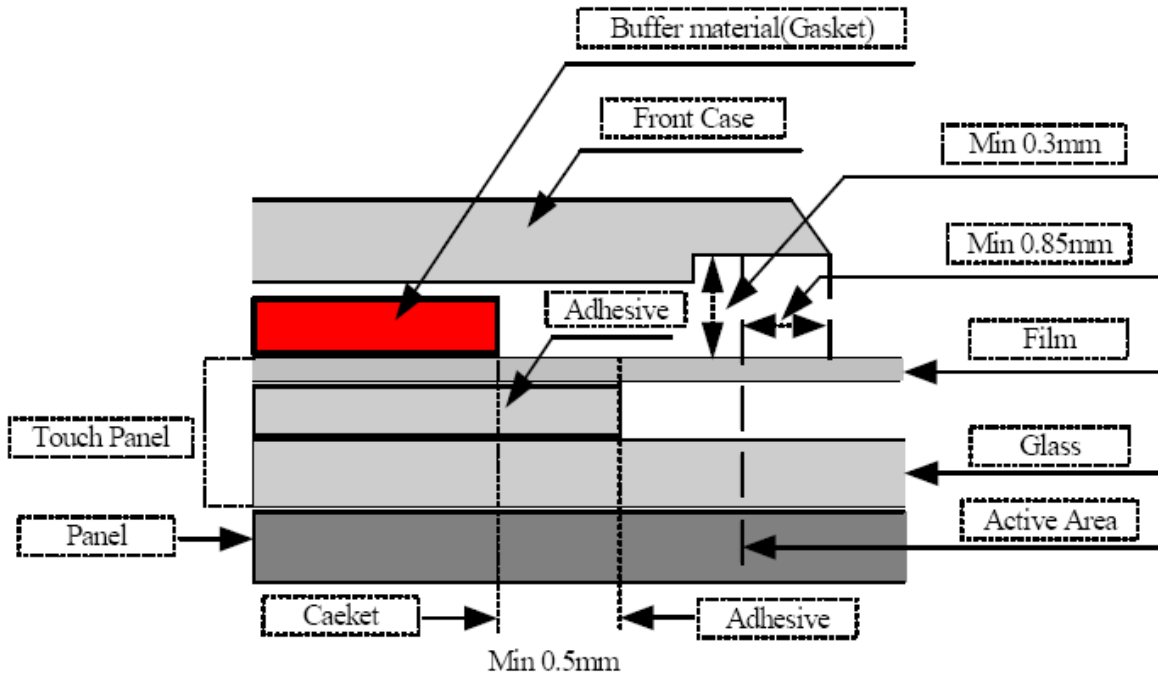

11. Operation Manual

11.1 Driver Board Manual

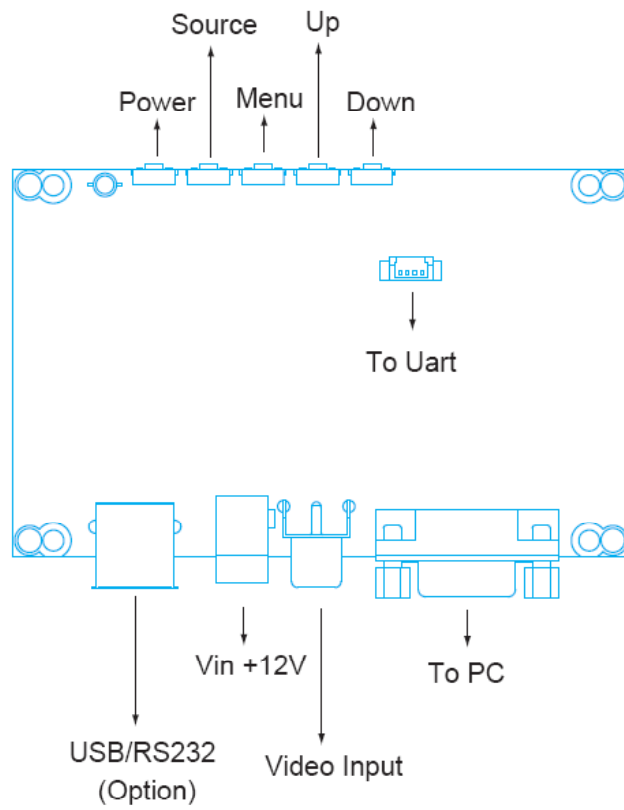

TECH

12. Packing List

Before you begin installing the KIT, please make sure that the following materials have been shipped:



A. LASTD12025-FDR



B. LAAC818000-FDR



C. LAVDO18000-FDR



D. LAVGA16000-FDR



E. LAUSB18000-FDR



F. LARS218000-FDR



G.

- A. AC to DC Adapter (L:1500mm, 100-240VAC 50-60Hz to +12VDC @ 2.5A)
- B. Power Cord (L:1800mm, Plug Type B for USA)
- C. Video Cable (L:1800mm)
- D. VGA Cable (L:1600mm)
- E. USB Cable (L:1800mm)
- F. RS-232 Cable (L:1800mm)
- G. Touch Screen Driver CD Disk / User Manual

If any of these items are missing or damaged, contact your distributor or sales representative immediately.

FLAT DISPLAY TECHNOLOGY

■ LP043A7IB_x-F_xR V0.0 

13. Key Function by OSD

13.1 Menu Operation

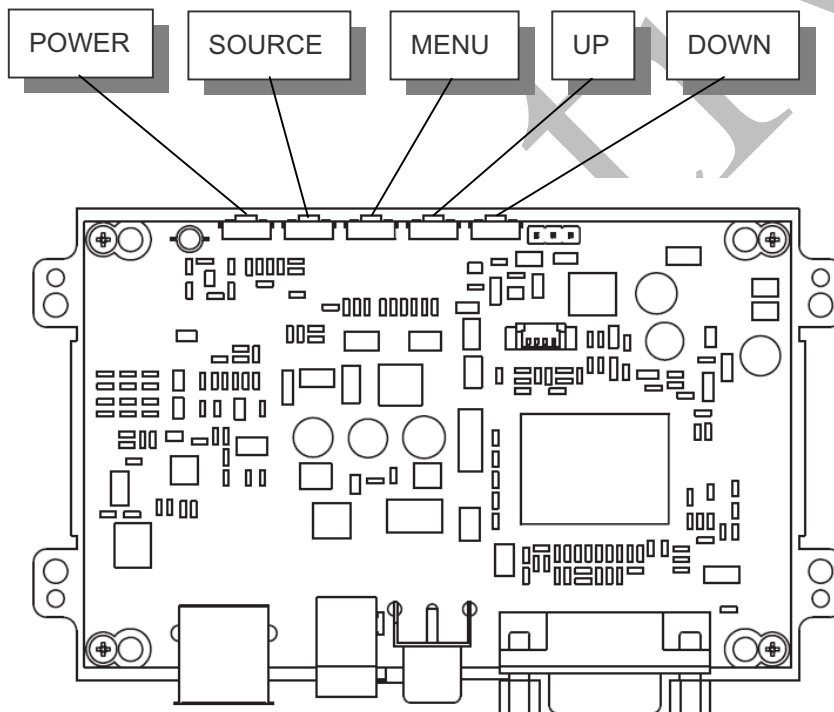
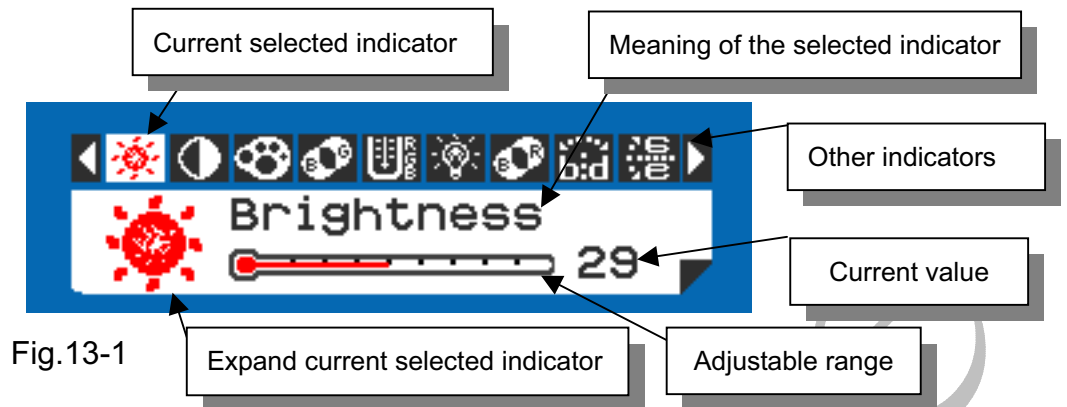

Operations of key board :

1. To navigate the menu, press [MENU]. (Fig.13-1)
2. The indicator lighting up in white color is the selected adjustment item.
3. To Next Item of the menu, press [MENU] again.
4. The operations below are only available when "Menu" is started.
5. Press [UP] / [DOWN] to adjust the value of the selected item.

Overview of the menu :

Firmware Version must be \geq VER 0.26















Indicator	Meaning	Adjustable range	For	Remark
	Brightness	0 ~ 64	AV / VGA	Adjust-Bar
	Contrast	0 ~ 64	AV / VGA	Adjust-Bar
	Color	0 ~ 64	AV	Adjust-Bar
	Tint	0 ~ 32	AV	Adjust-Bar
	Sharpness	0 ~ 16	AV	Adjust-Bar
	Dimmer	0 ~ 9	AV / VGA	
	Color Tone	Normal / Warm / Cool	AV / VGA	
	H-Position	-25 ~ +25	AV / VGA	Balance-Bar
	V-Position	-10 ~ +10	AV / VGA	Balance-Bar
	Auto		VGA	
	Scan	Over Scan / Under Scan	AV	
	Information		AV / VGA	Fig.13-2
	Setup		AV / VGA	Fig.13-3
	Factory Set		AV / VGA	
	Exit		AV / VGA	

Fig.13-2



Setup Menu :

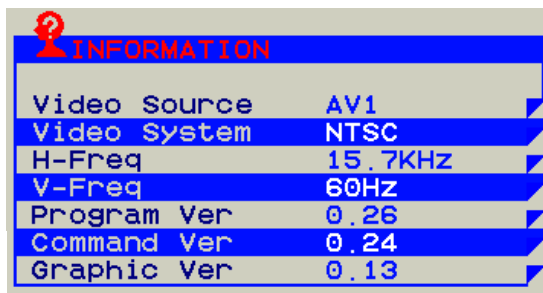

Fig.13-3

Indicator	Meaning	Adjustable range	Function	Remark
	Show Status	ON / OFF	Show signal status.	ON: Show OFF: Hidden
	Blue Screen	ON / OFF	If loss signal will put on the blue or black screen.	ON: Blue OFF: Black
	Auto Power On	ON / OFF	Power input module will be auto turn on.	ON: Auto OFF: Manual
	Auto Saving	OFF / 3s / 5s / 15s / 30s	If signal lost over setting times will be power off.	ON: Auto OFF: Normal
	Detect Source	ON / OFF	Auto detection which source is existence and change.	ON: Auto OFF: Normal
	Return			

Note : VGA only type don't have Detect Source function.

13.2 Operations

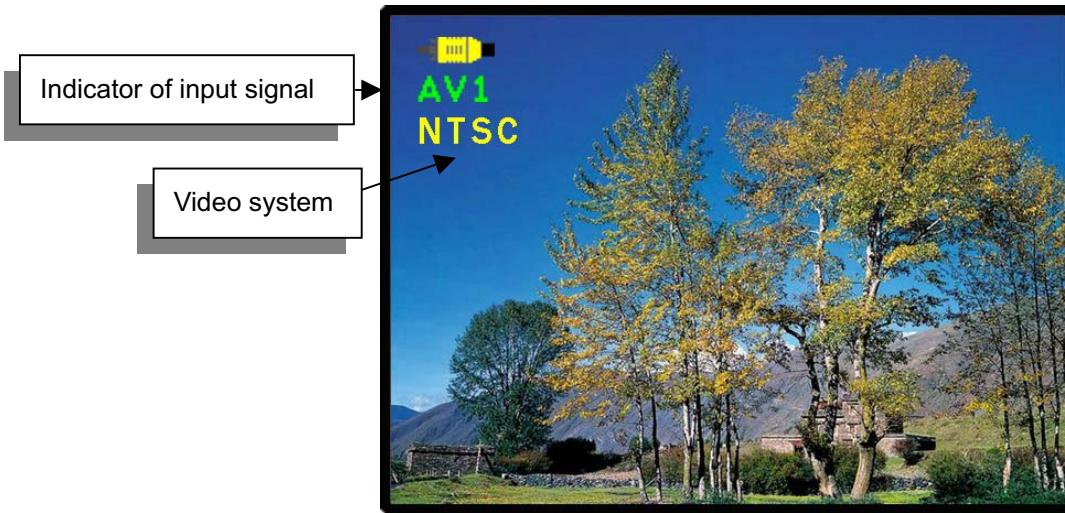



Fig.13-4

[Power] : Monitor power on / off

[Source] : Input signal switch

Overview of input signals :

Indicator	Input signal	Interface	Video system
	AV1	Composite	NTSC / PAL / SECAM
	VGA	Analog RGB	640x480_60 / 800x600_60 / 1024x768_60