

Packing List

- BEGV627M Embedded System
- User Manual
- Software Utility Disc
- ICD 3 and ISP Cable (option)

BEGV627M BLOCK DIAGRAM

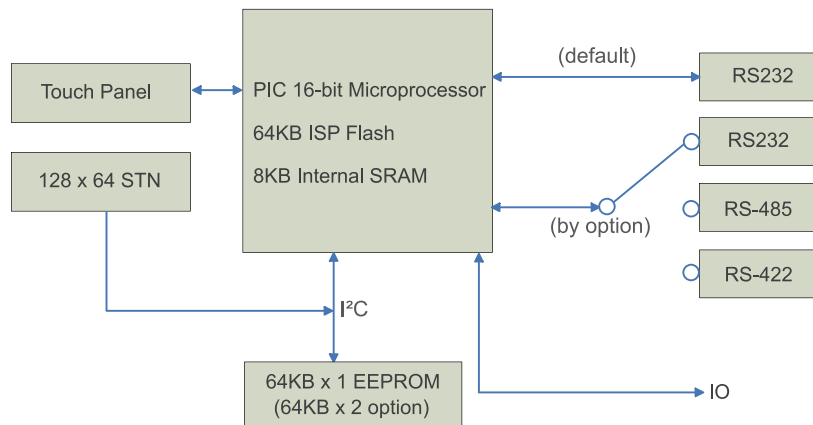

Pin Mapping Table

PIN NO.	Signal	PIN NO.	Signal
1	VDD	7	422TP/485P/TX1
2	GND	8	IOA
3	422RP	9	422TN/485N/RX1
4	TX0	10	IOB
5	422RN	11	/RST
6	RX0	12	IOC

Order Information

Parts NO.	Description	RS232-A	RS232-B	RS422	RS485
BEGV627M	Dual RS232	☆	☆		
BEGV627M1	One RS232	☆			
BEGV627M2	One RS232/One RS422	☆		☆	
BEGV627M3	One RS232/One RS485	☆			☆

Display: FSTN/Gray LCD,LED/White Backlight(Default)

