

Packing List

- BEGV643A Embedded System
- User Manual
- Software Utility Disc
- MKII and ISP Cable (option)

BEGV643A BLOCK DIAGRAM

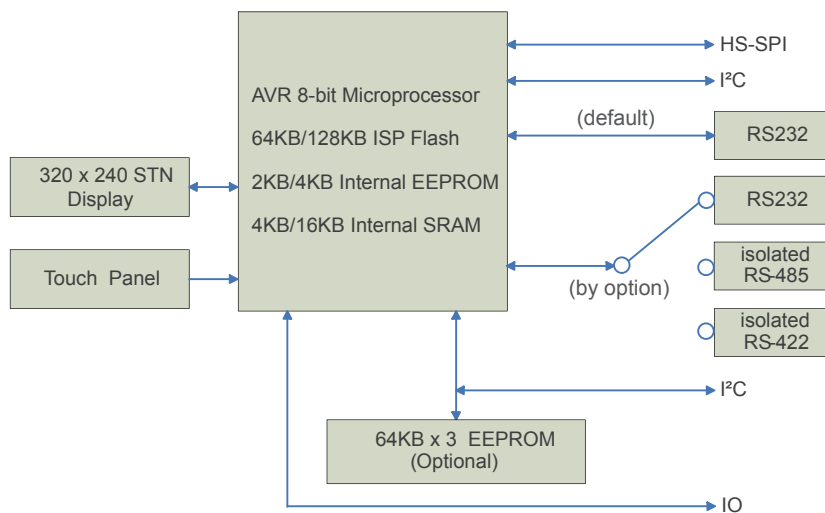

Pin Mapping Table

PIN NO.	Signal	PIN NO.	Signal	PIN NO.	Signal
1	GND	12	422RP	23	RX1
2	EEPSDA	13	MOSI	24	GND2
3	VDD	14	422RN	25	TX1
4	EEPSCL	15	MISO	26	GND2
5	Vadj	16	422TP/485P	27	SDA
6	EEPWP	17	SCK	28	EN485
7	Vout	18	422TN/485N	29	SCL
8	IOB	19	RX0	30	A
9	/Reset	20	VDD2	31	IOA
10	NC	21	TX0	32	K
11	/SS	22	VDD2		

Order Information

Parts NO.	Description	RS232-A	RS232-B	RS422	RS485
BEGV643A	Dual RS232	☆	☆		
BEGV643A1	One RS232	☆			
BEGV643A2	One RS232/One RS422	☆		☆	
BEGV643A3	One RS232/One RS485	☆			☆

Display: FSTN/Gray LCD,LED/White Backlight(Default)

