

§ SPECIFICATION APPROVAL SHEET §

FDT Tech Module No. : UC070Wlx0x-00R

Description : 7" Digital TFT-LCD Module

SPEC No. : SAS-1702005

Version : 0.1

Issue Date : August 29, 2018

※ This approval sheet contains 23 pages including the cover and appendix.

Customer : Date : / / 18	Approved By :
---	----------------------

Approved By :

Checked By :

Designed By :





1. General Description

FDT Micro Controller-HMI is a unique TFT LCD module which builds graphic and character inside. It provides user to present customized & full color graphics or characters without any SOC or IPC system. In addition, user can update or upload his graphics or characters via Micro SD slot by himself. FDT Micro Controller-HMI not only enhances your product values also saves your cost.

1.1 Features

- Variable-Oriented
- Friendly and Free Development Environment
- Multi-layer design
- Advanced GUI function
- Easy Touch Effects
- Multi-Language (Unicode)
- Easy and fast update image with Micro SD
- Single Operation Voltage +5V
- Built-in Real Time Clock / Buzzer
- LED Backlight Brightness Control
- RAM Support 16MB / Flash Memory 256MB
- 4Wires RTP Touch Support
- Serial Communication: UART (RS232 Option)
- Low Power Consumption / High reliability

1.2 Application

- Industrial controller
- Medical Equipment
- Security Equipment
- Simple Function Equipment



2. Contents

Contents	Page
1. General Description	1
1.1 Features	1
1.2 Application	1
2. Contents	2-3
3. Specifications	4
4. Block Diagram	4
4.1 Block Diagram	4
5. Order Information	5
5.1 Unit	5
5.2 Accessories (Option)	5
6. Absolute Maximum Ratings	6
6.1 Absolute Maximum Ratings	6
7. Recommended Operating Conditions	6
7.1 Electrical Characteristics	6
8. Pin Description	7-8
8.1 J107A Pin Assignment of Signal Input (Pitch 2.0mm 7Pin,Side Entry Type)	7
8.2 UART Timing Chart (Client Side)	8
8.3 RS232 Timing Chart (Client Side)	8
9. 4W Resistance Touch Panel Characteristics	9-11
9.1 Optical Performance	9
9.2 Mechanical Performance	9
9.3 Durability Performance	9
9.4 Touch Screen Integration Design Guide	10
9.5 Mechanical Design Notice For Touch Panel	11
10. Buzzer Notice	12
10.1 Remove Buzzer Label	12
11. The Built-in Demo Project of the Module	13
11.1 Operation Explaining	13
12. Dimension Information	14-17
13.1 Unit(UC070WIA00-00R)	14
13.2 Unit(UC070WIA04-00R)	15
13.3 Unit(UC070WIB00-00R)	16
13.4 Unit(UC070WIB04-00R)	17
13. Accessory (Drawing)	18-21
13.1 Application Circuit (Option)	18
13.2 Application Board Dimension (Option)	19
13.3 LACABLE008-FDR (Option)	20
13.4 LACABLE09-FDR (Option)	21



14. Appendix.....	22
14.1 TFT-LCD Mechanical Specifications	22
14.2 TFT-LCD Optical Characteristics	22

Preliminary

3. Specifications

LCD	
Panel Size	7"
Resolution (Pixels)	800x480
Luminance Without RTP	400cd/m ²
Luminance (RTP)	320 cd/m ²
Contrast Ratio	500
View Angle	70 / 70 / 70 / 50
LED Life Time	20K (Min.)
Touch Screen	
Resistive Type	4W
Storage	
Micro SD Slot	Recommend SDHC
Flash Memory	256M Bytes (Note1)
RAM	16M Bytes (Note2)
Picture Format	
Type	BMP category

Power Requirement			
Power Input	+5V VDC		
Power Consumption@+5V	3.15 Watts (±15%)		
Controls			
Transmission Interface	UART / RS232 (Duplex Transmission)		
Communication Protocol			
UART Transmission Rate	115200 (max.921600bps) Bps		
Data Bit	8 Bits		
Parity Bit Check	None		
Stop Bit	1 Bit		
Environment			
Temperature Range	Without RTP	4W RTP	
	Operating	-20~+70°C	-10~+60°C
	Storage	-30~+80°C	-30~+80°C
High Temperature & High Humidity (No Condensation)	Operating	+40°C / 90%	+35°C / 90%

Note 1: Storage memory for Icons, Pictures, Fonts and configure.

Note 2: GUI cache memory

4. Block Diagram

4.1 Block Diagram

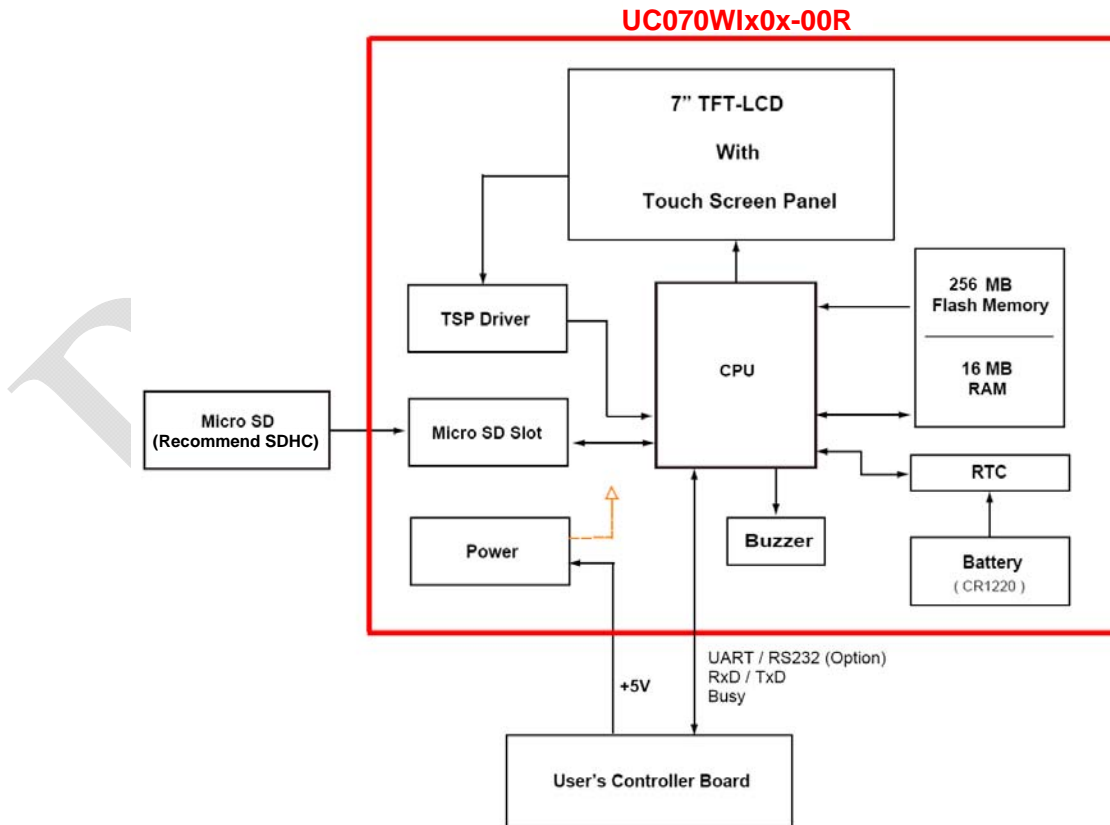



5. Order Information

5.1 Unit



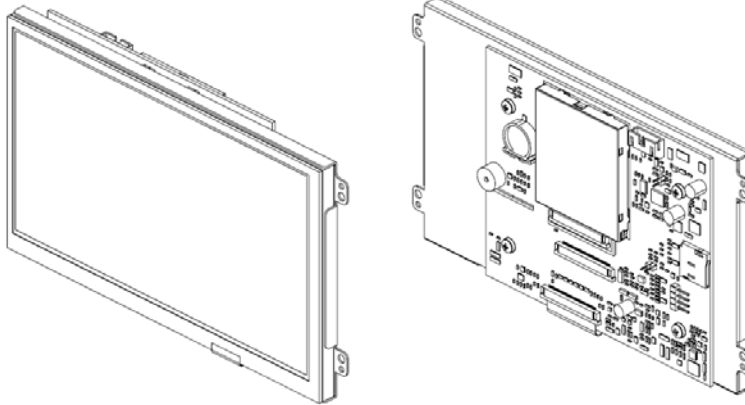

Unit



Parameter	UC70WIA00-00R	UC70WIA04-00R	UC70WIB00-00R	UC70WIB04-00R	Unit	Remark
RTC	◎	◎	◎	◎		
Touch Screen Function	-	4W Resistance	-	4W Resistance		
Outline Dimension	177.2x101.8x18.9	177.2x101.8x20.6	177.2x101.8x18.9	177.2x101.8x20.6		
Buzzer Function	◎	◎	◎	◎		
Transmission Interface	UART	UART	RS232	RS232		
Weight	340	385	340	385	g	±10%
Condition	Standard	Standard	Non- Standard	Non- Standard		

Note: The assembling of panel and bracket is aimed for delivery, packaging and experiment. If the demand of shockproof and long-term fix, pls have it into consideration of mechanism design.

5.2 Accessories (Option)

NO.	Item	Order P/N	Picture	Remark
1.	7P 2.0mm - 4P1.25mm - 5.5mm DC Jack 2.1 φ	LACABLE008-FDR		Only for UC070WIA0x-00R
2.	GCK-003 Signal Cable 7Pin 2.0mm to 7Pin 1.25mm (L:150mm)	LACABLE009-FDR		Only for UC070WIB0x-00R
3.	RS232 Board	LOPOWER014-FDR		
4.	Female/Female Null Modem Type L:1800mm	LACABLE045-FDR		

6. Absolute Maximum Ratings

6.1 Absolute Maximum Ratings

Parameter	Symbol	Min	Max	Unit	Remark
Input Voltage	Vin	+4.2	+5.7	V	
UART Mode	TXD / BUSY	+0.3	+3.8	V	
	RXD	+0.3	+5.5	V	
RS232 Mode	TXD / BUSY	-6	+6	V	
	RXD	-15	+15	V	
Operating Temperature Without RTP		-20	+70	°C	
Operating Temperature With RTP		-10	+60	°C	
Storage Temperature Without RTP		-30	+80	°C	
Storage Temperature With RTP		-30	+80	°C	
High Temperature & High Humidity (No Condensation) With RTP			+35 / 90	°C / %	
High Temperature & High Humidity (No Condensation) Without RTP			+40 / 90	°C / %	

7. Recommended Operating Conditions

7.1 Electrical Characteristics

Parameter	Symbol	Min	Typ	Max	Unit	Note
Input Voltage	Vin	+4.5	+5	+5.5	V	
Total Current	Iin (+5V)	-	630	-	mA	±15%
Power Consumption		-	3.15	-	W	@5V
UART Mode	TXD / BUSY	+0.3	+3.3	-	V	
	RXD	+0.3	+3.3	+5.3	V	
RS232 Mode	TXD / BUSY	-5	-	+5	V	
	RXD	-12		+12	V	

8. Pin Description

8.1 J107A Pin Assignment of Signal Input (Pitch 2.0mm 7Pin, Side Entry Type)

- ※ FDT Connector Part No.: S7B-PH-K-S (JST) or [Same as M24267R (STM)];
- FDT Matching Connector Part No.: PHR-7 (JST) or [Same as P24267 (STM)]

Pin No	Symbol	I/O	Description	Remark
1	VCC5V	-	+5V Input Voltage	DC
2	VCC5V	-	+5V Input Voltage	DC
3	GND	-	Ground	
4	GND	-	Ground	
5	BUSY	O	Busy status	(Note1,2)
6	RXD	I	Receive Data	
7	TXD	O	Transmit Data	

Note: 1. Your application circuit board must be connects with BUSY pin of uC-HMI.

	BUSY Active	BUSY Inactive
UART Mode	+3.3V	0V
RS232 Mode	-5V	+5V

2. BUSY circuit of UART Mode

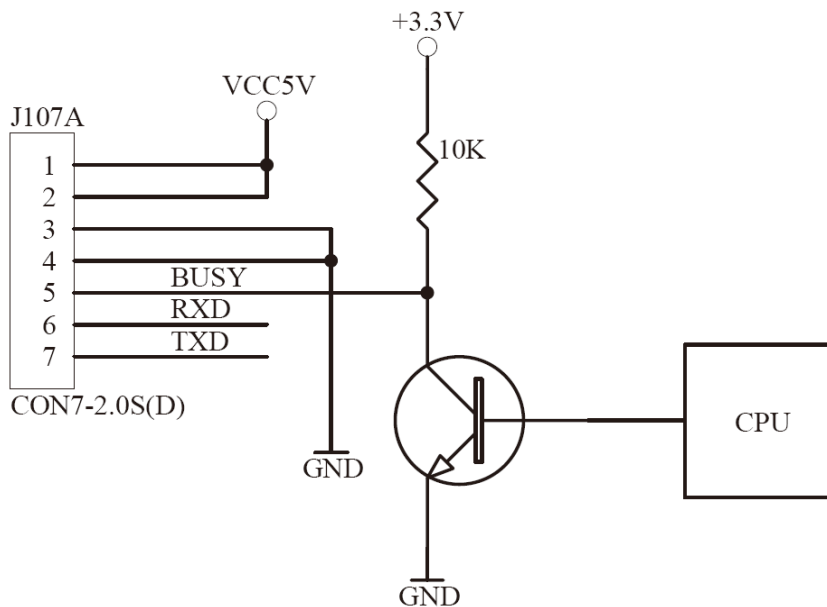



8.2 *UART Timing Chart (Client Side)*

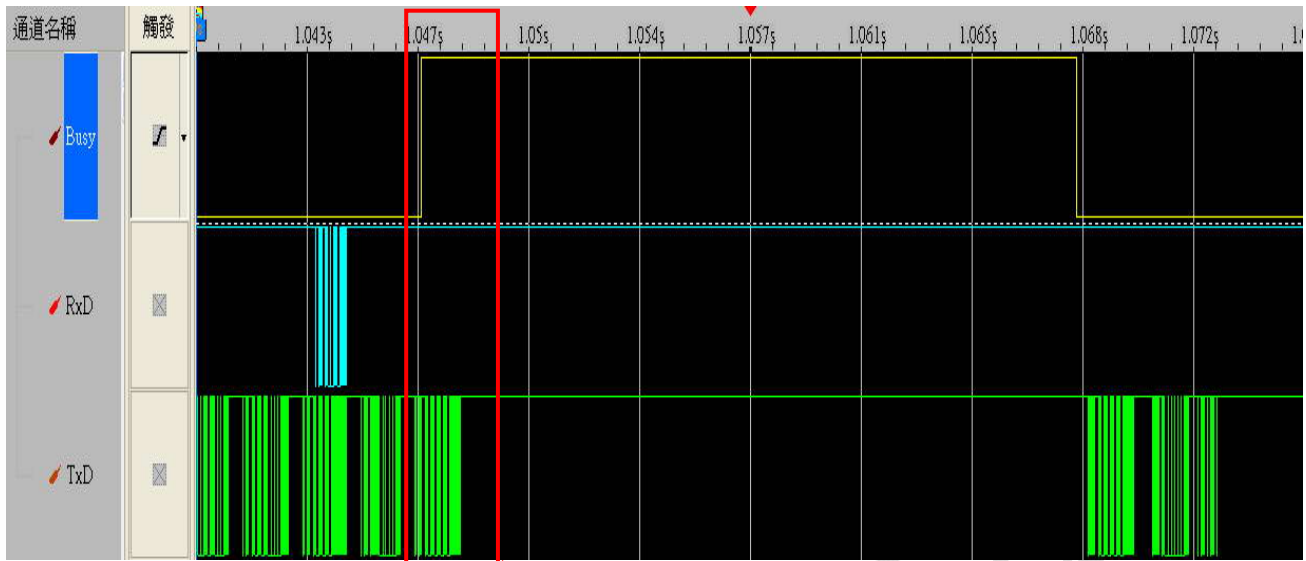

※ If busy signal of uC-HMI appears on the duration of client processor transmission command. Please don't worry this situation and goes on last command procedure.

8.3 *RS232 Timing Chart (Client Side)*

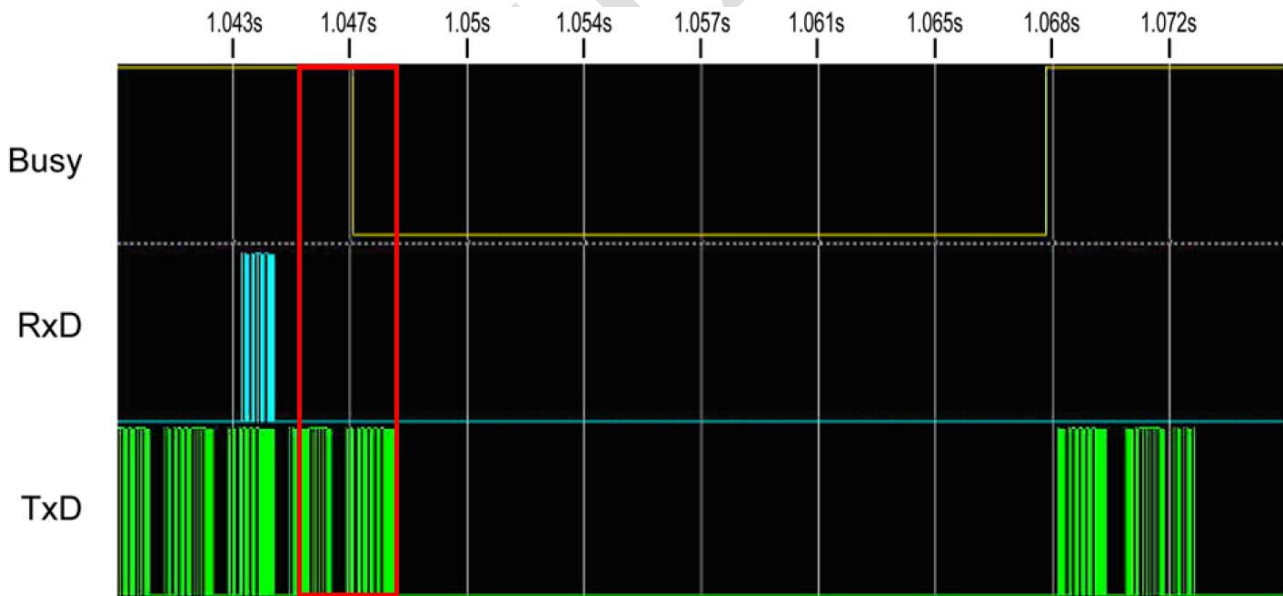

※ If busy signal of uC-HMI appears on the duration of client processor transmission command. Please don't worry this situation and goes on last command procedure.



9. 4W Resistance Touch Panel Characteristics

9.1 Optical Performance

Parameter	Specifications
Transmittance	$\geq 78\%$
Haze	$8\% \pm 2\%$

9.2 Mechanical Performance

Parameter	Specifications
Input Method	Finger or stylus pen
Operating Force	Max: 100g
Surface Hardness	3H or more

9.3 Durability Performance

Parameter	Specifications
Knock Test	1,000,000 times (Silicon rubber,R8)
Lineation Test	100,000 times (Polyacetal ,R0.8)



9.4 Touch Screen Integration Design Guide

Avoid the design that Front-case overlap and press on the active area of the touch-panel.

Give enough gap (over 0.5mm at compressed) between the front case and touch-panel to protect wrong operating.

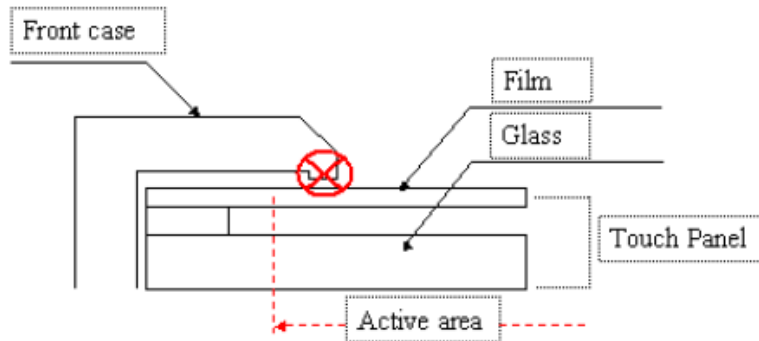

Use a buffer material (Gasket) between the touch-panel and front-case to protect damage and wrong operating.

Avoid the design that buffer material overlap and press on the inside of touch-panel viewing area.

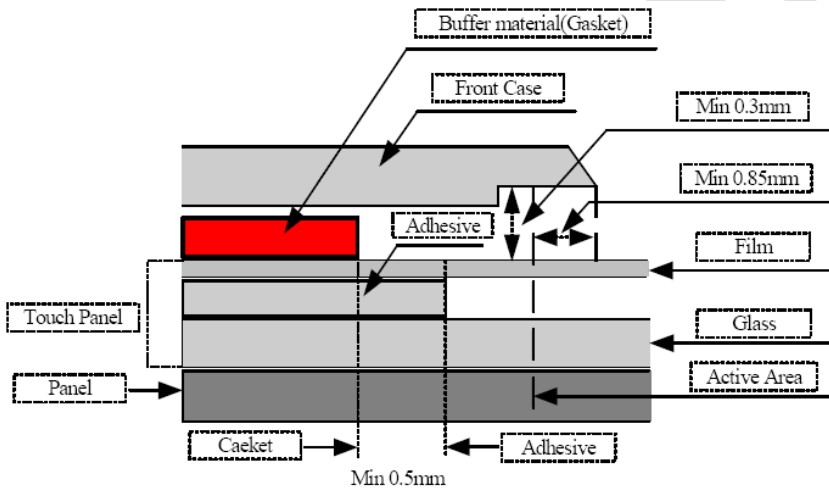

Note: We strongly suggest to follow above design guide to avoid the linear defect happened on the touch panel.



9.5 Mechanical Design Notice For Touch Panel

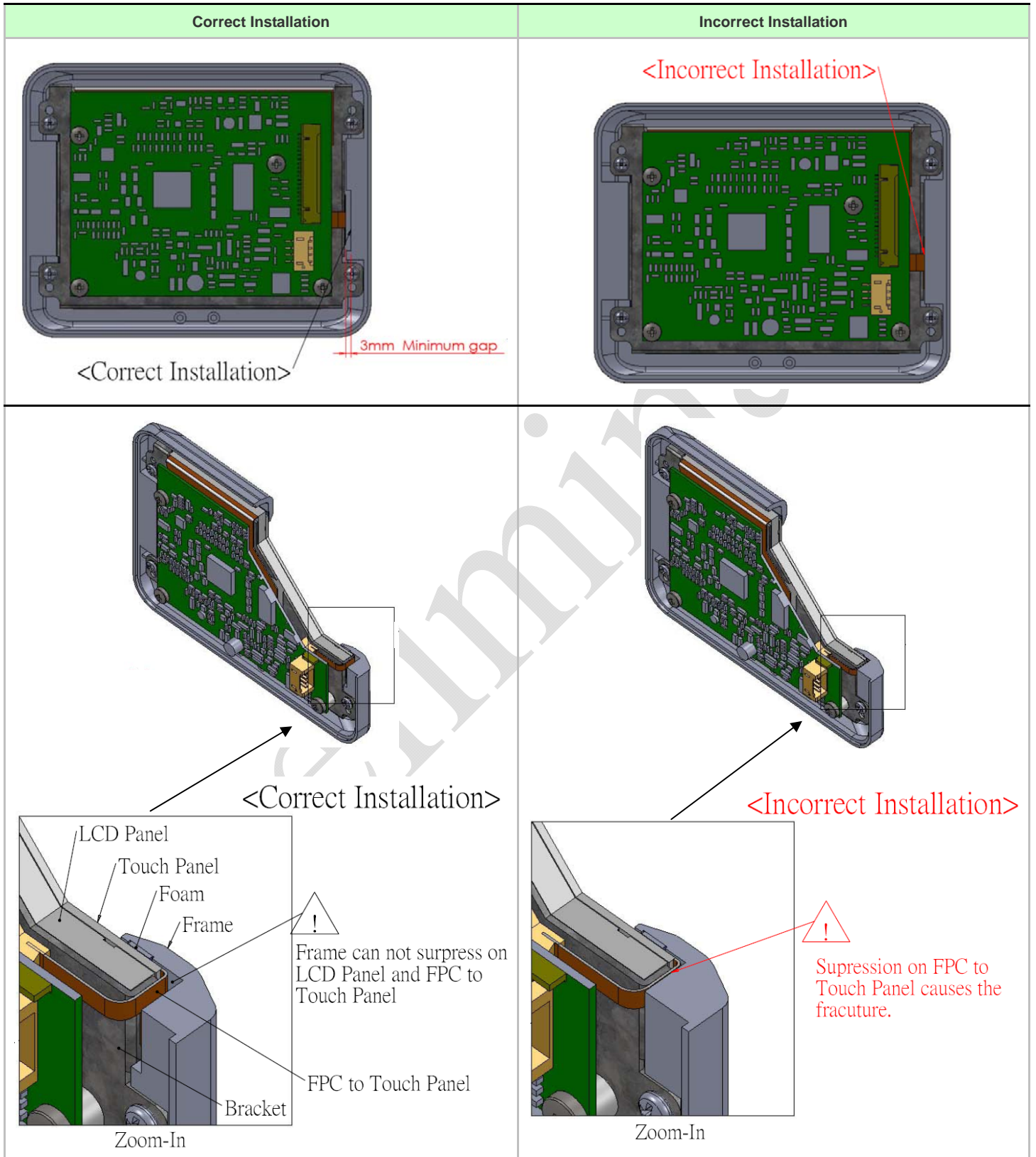



10. Buzzer Notice

10.1 Remove Buzzer Label

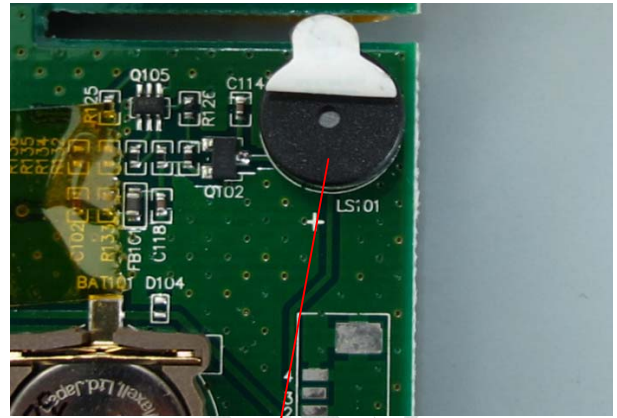
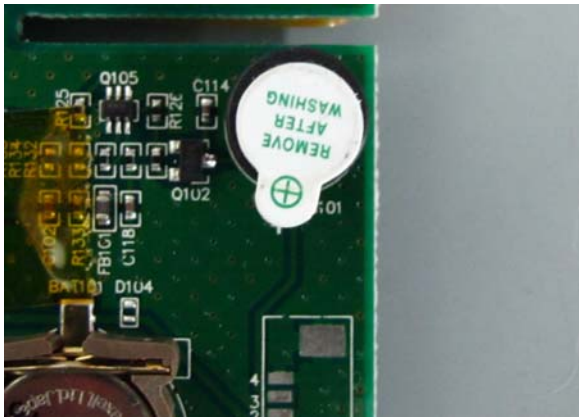

Remove

Preliminary



11. The Built-in Demo Project of the Module

11.1 Operation Explaining

The uC-HMI module delivery is included a project.

How to use that please refer to the document as “uC-HMI_Module_Demo_User_Guide.pdf”

File located : <Disc:\Project of Standard Module II\Documents>

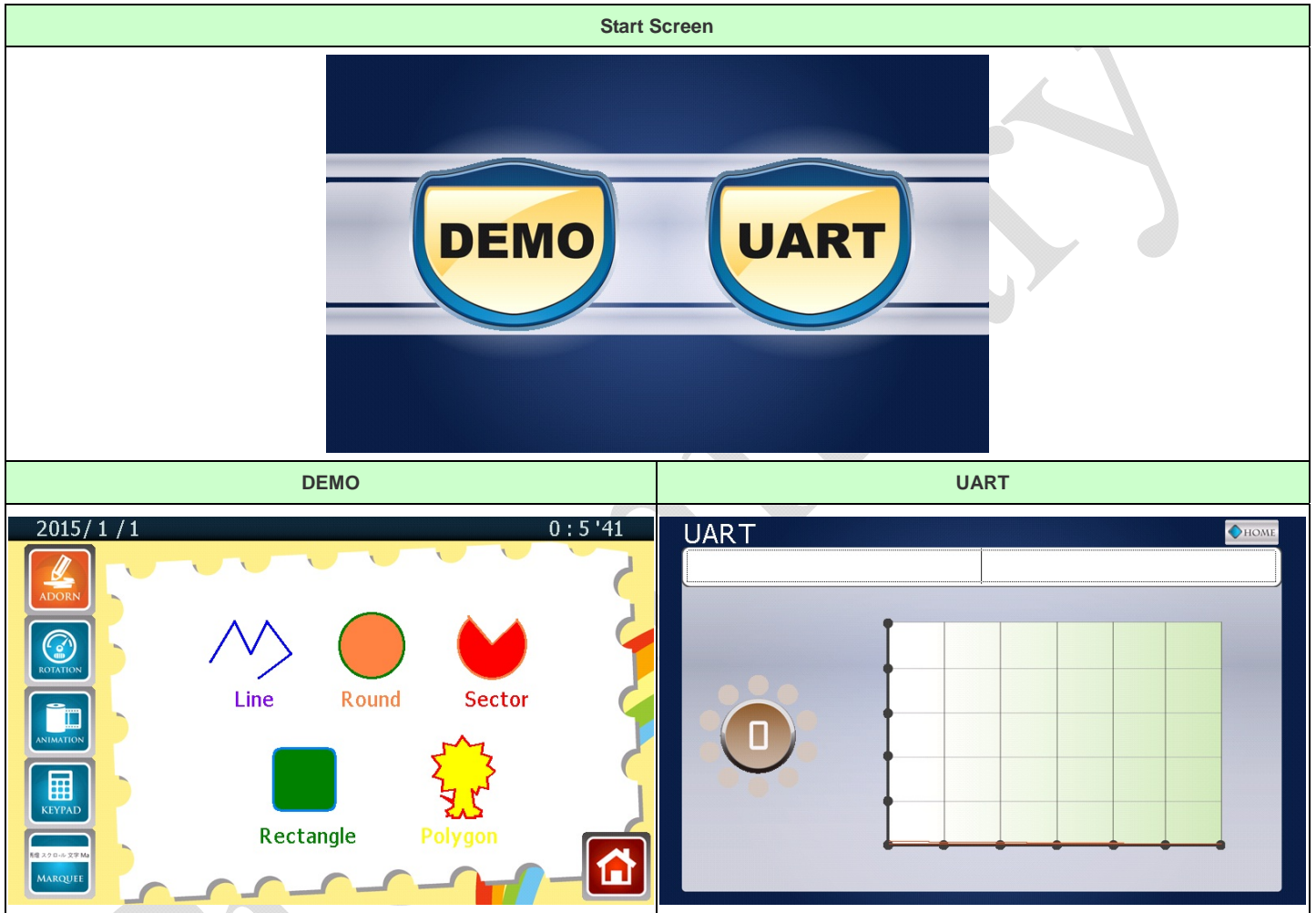



12. Dimension Information

12.1 Unit (UC070WIA00-00R)

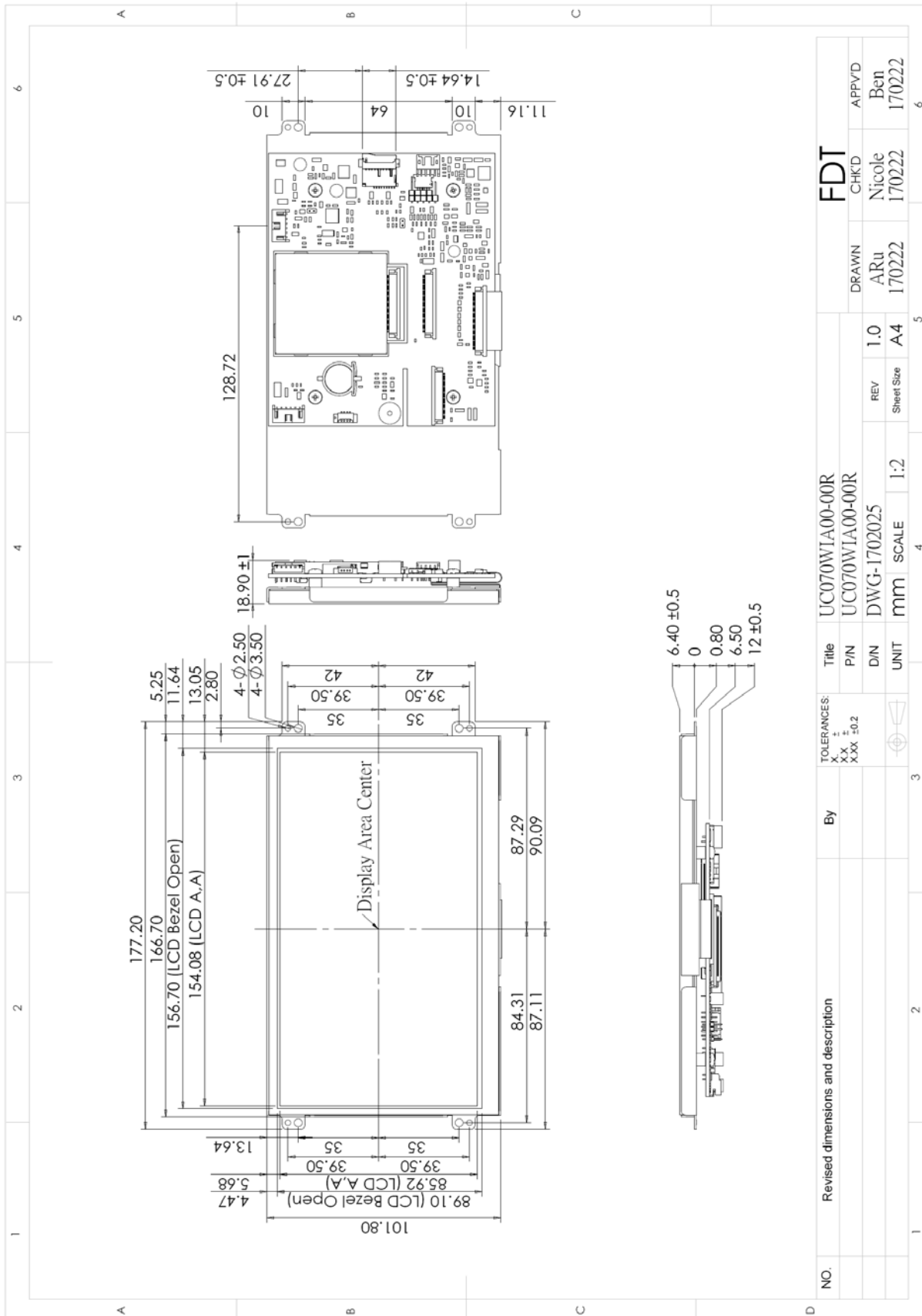



12.2 Unit (UC070WIA04-00R)

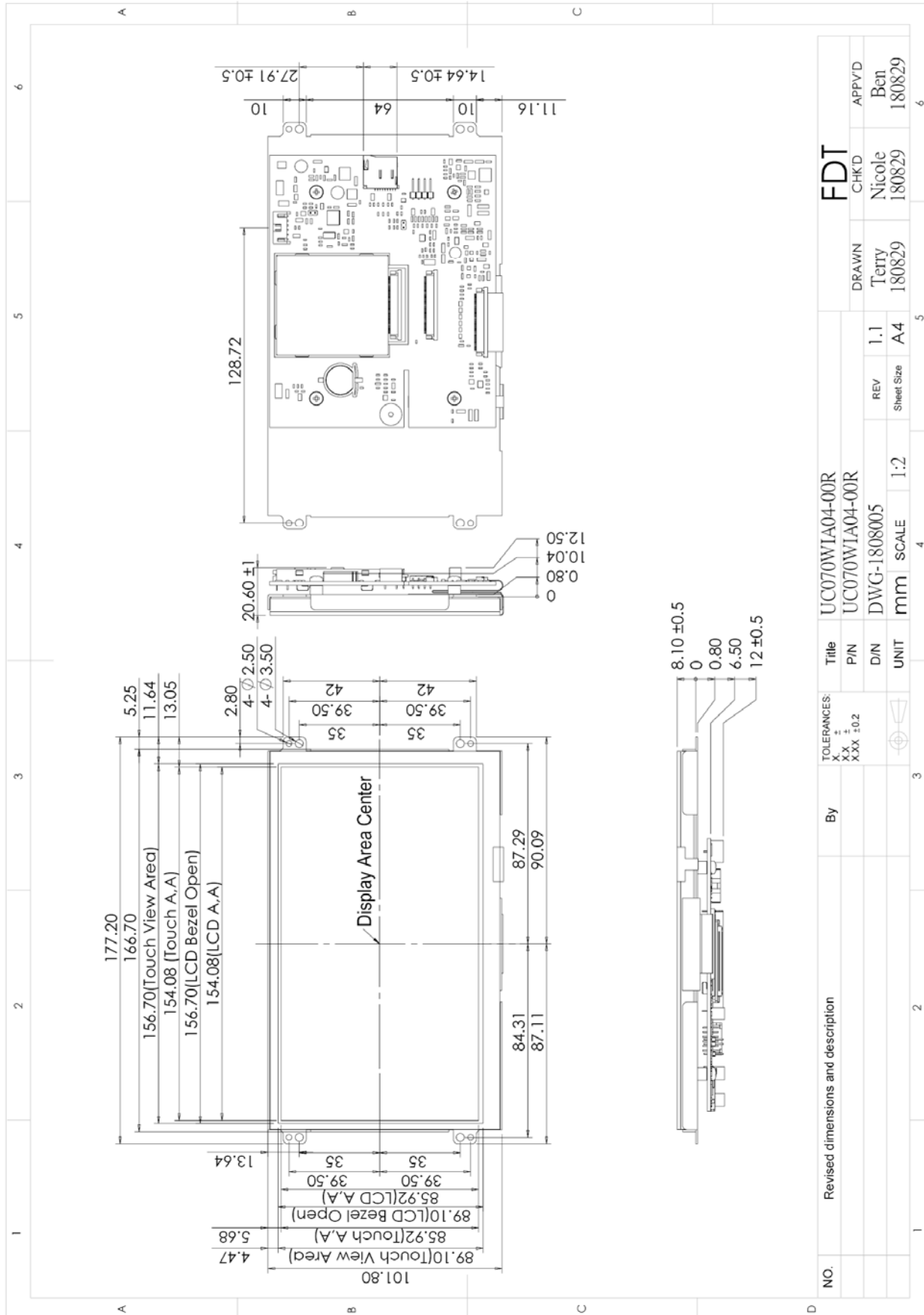

FDT

NO.	Revised dimensions and description	By	TOLERANCES: XX ± XXX ±0.2	Title		UC070WIA04-00R		FDT				
				PIN	D/N	UNIT	SCALE	REV	Sheet Size	DRAWN	CHK'D	APP'VD
					DWG-1808005	mm	1:2	1.1	A4	Terry	Nicole	Ben
										180829	180829	180829



12.3 Unit (UC070WIB00-00R)

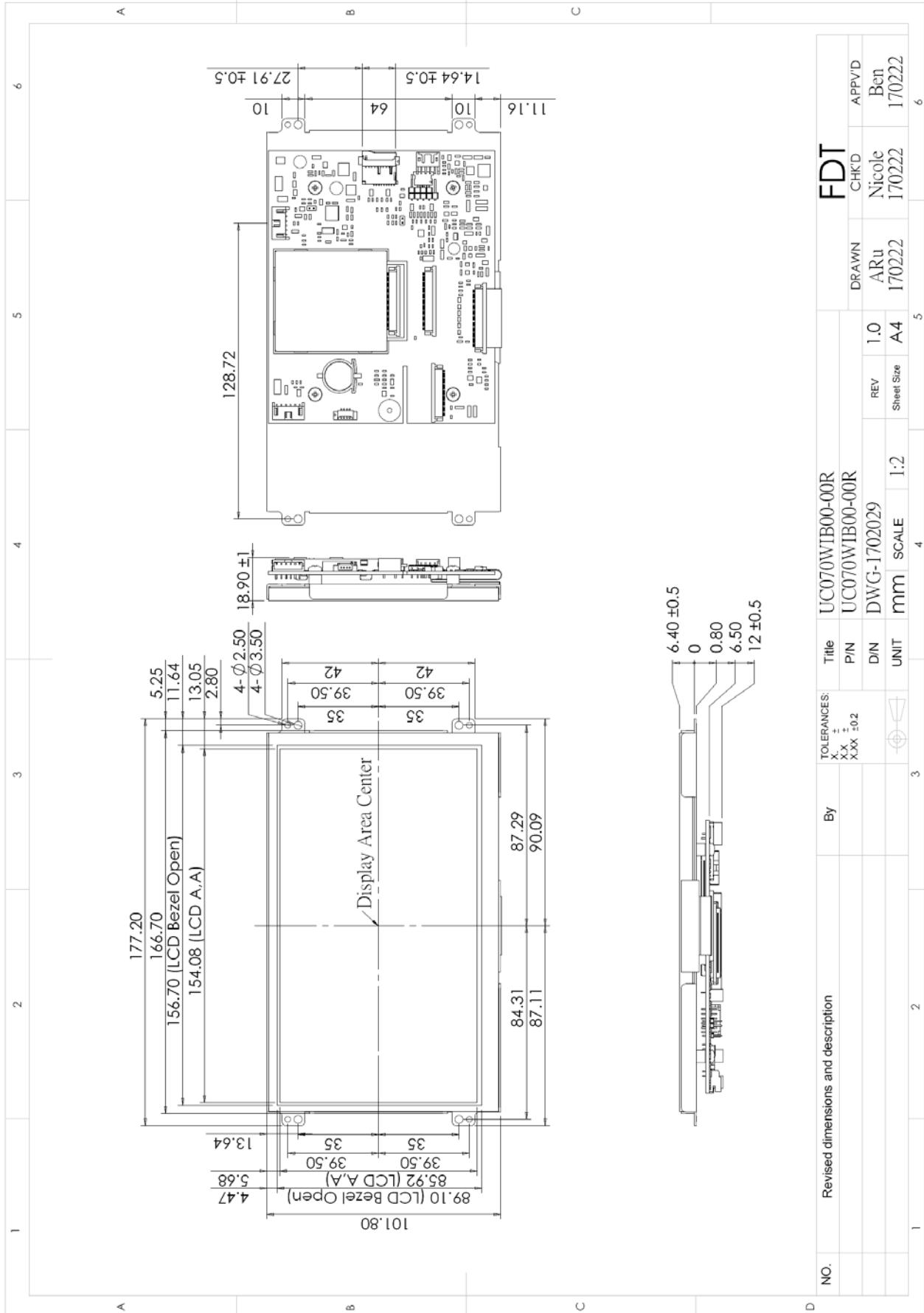



13. Accessory (Drawing)

13.1 Application Circuit (Option)

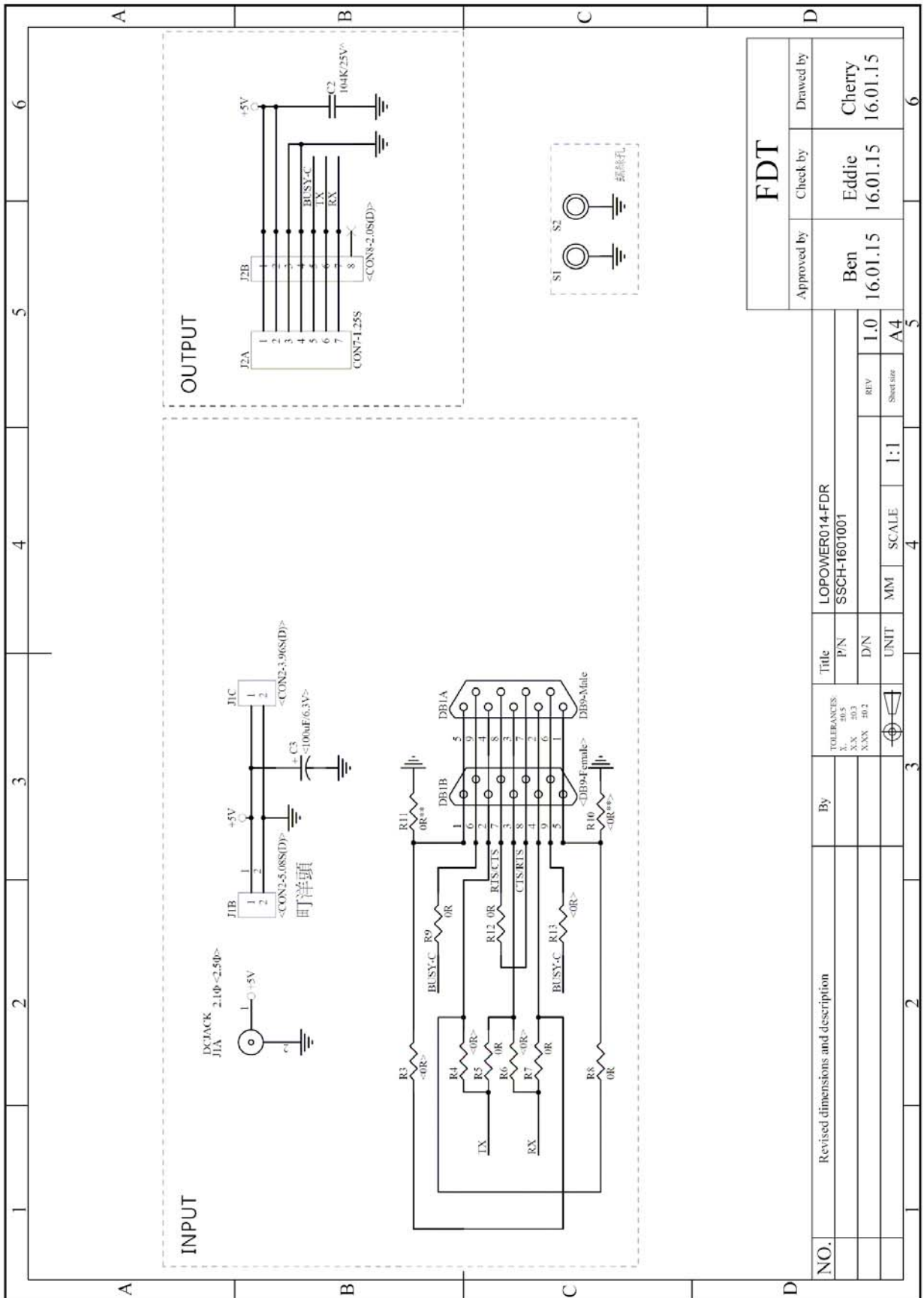



13.2 Application Board Dimension (Option)

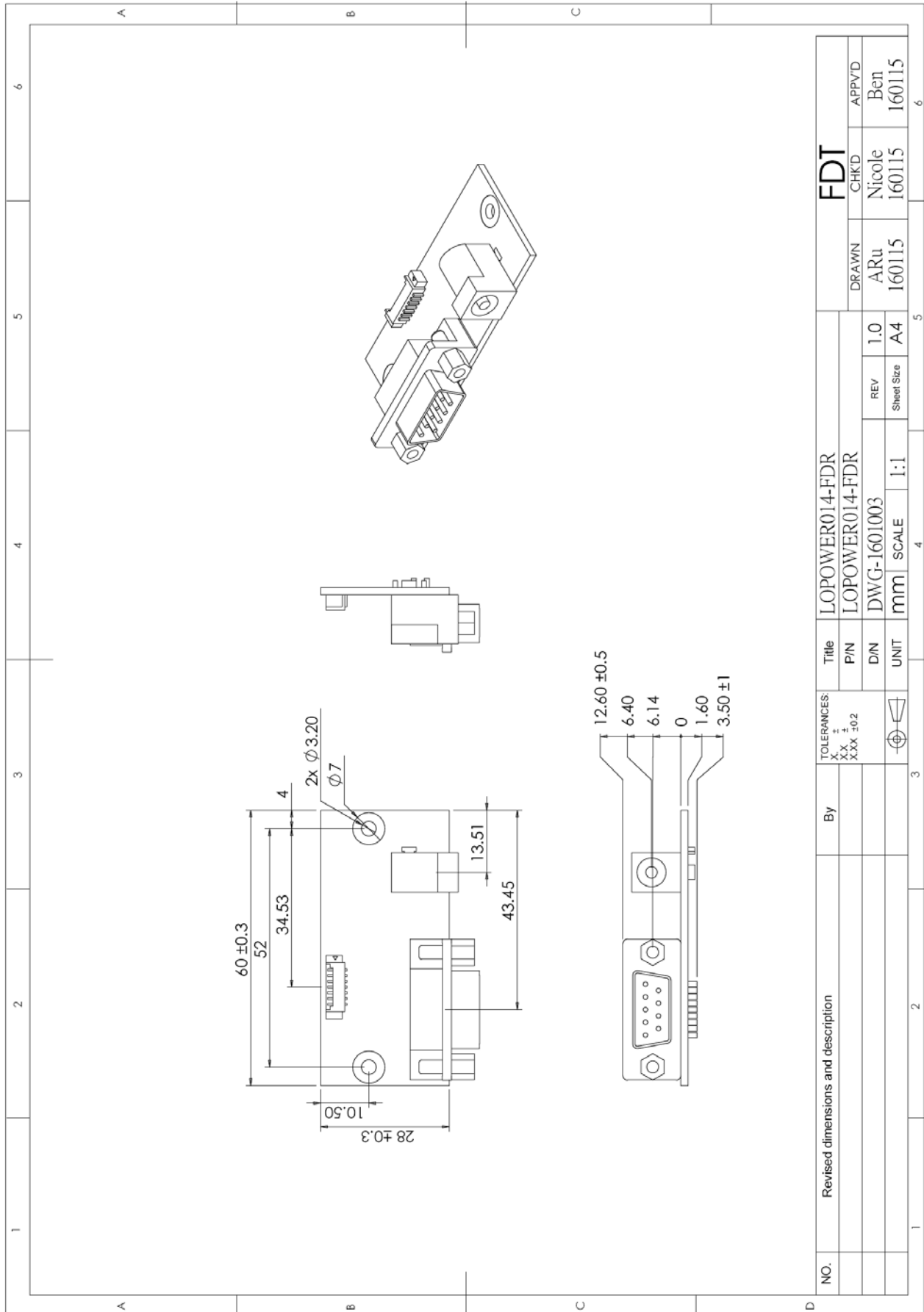



13.3 LACABLE008-FDR (Option)

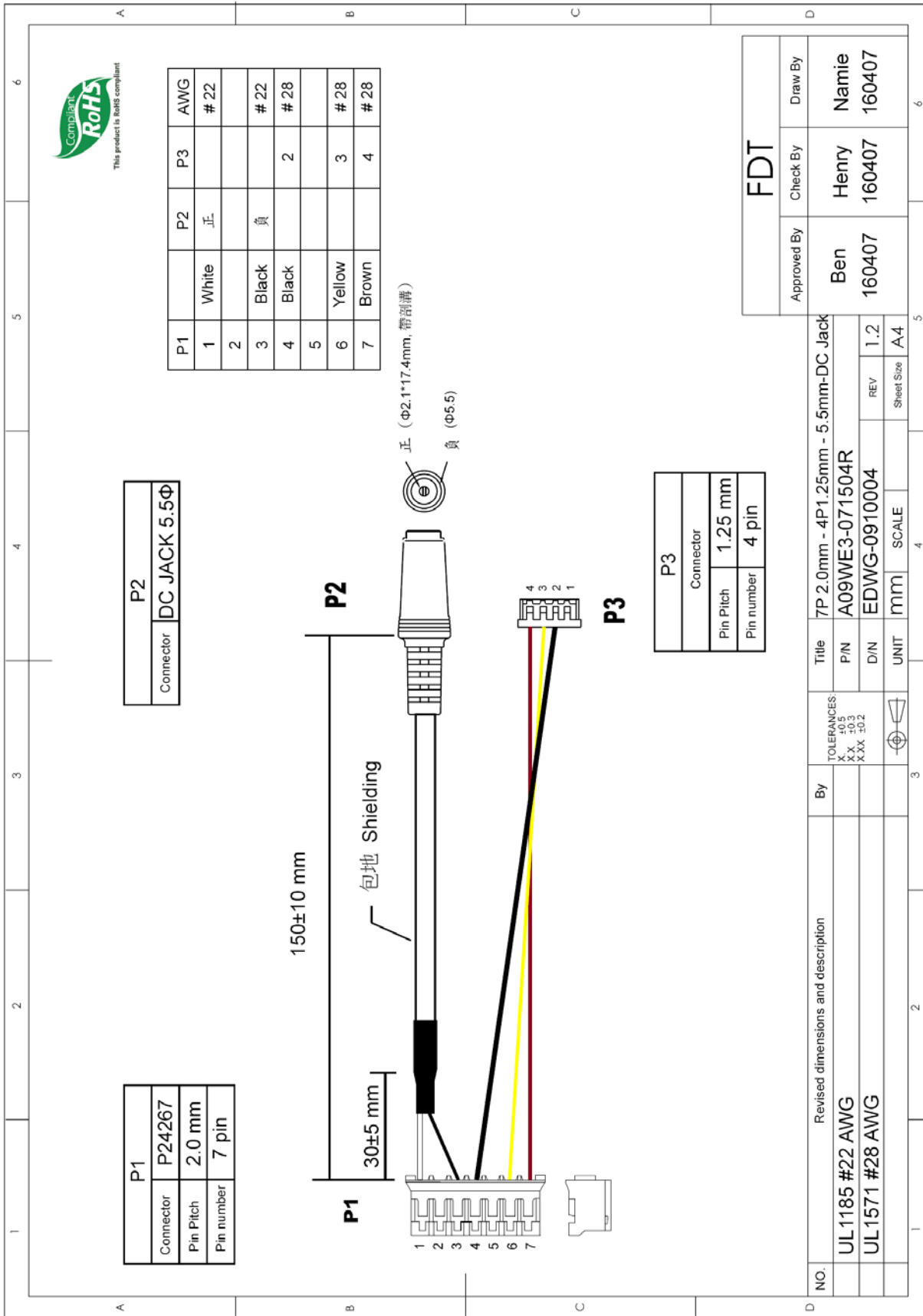



13.4 LACABLE09-FDR (Option)

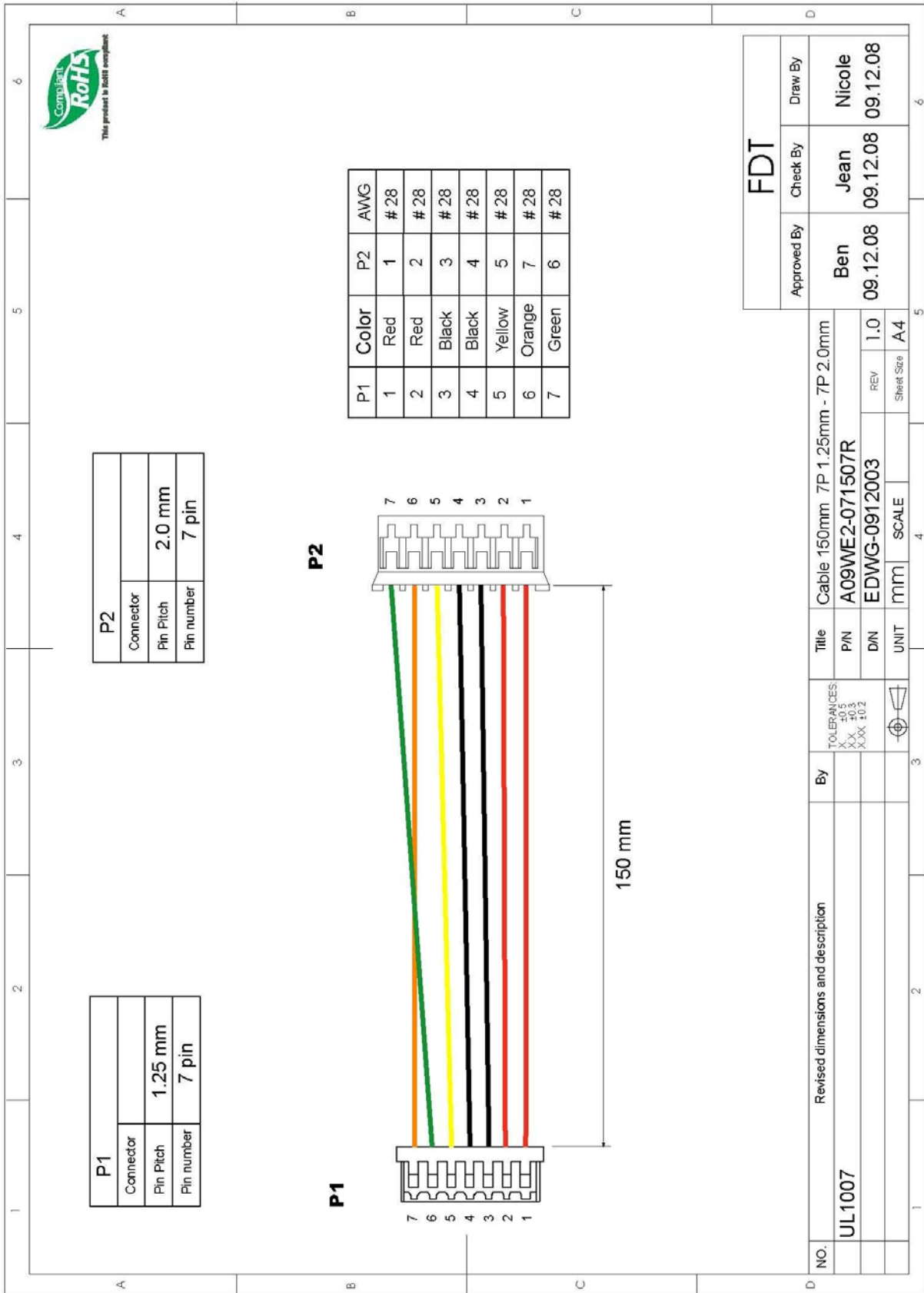

14. Appendix

14.1 TFT-LCD Mechanical Specifications

Parameter	Specifications	Unit
Screen Size	7" (Diagonal)	inch
Display Format	800 x (R.G.B) x 480	dot
Active Area	154.08(W) x 85.92(H)	mm
Surface Treatment	Anti-Glare	

14.2 TFT-LCD Optical Characteristics

Parameter	Symbol	Condition	Min	Typ	Max	Unit	Remark
Viewing Angle	Horizontal	Left	60	70	---	deg	
		Right	60	70	---	deg	
	Vertical	Top	40	50	---	deg	
		Bottom	60	70	---	deg	
Contrast Ratio	CR	At optimized Viewing angle	400	500	---	---	
Brightness Without RTP	L	$\Theta = 0^\circ / \phi = 0$	320	400	---	cd/m ²	
Brightness With RTP	L	$\Theta = 0^\circ / \phi = 0$	256	320	---	cd/m ²	
LED Life Time	---	$T_a = +25^\circ\text{C}$	20000	---	---	Hrs	$I_L = 180\text{mA}$ Note

Note: The "LED Life Time" is defined as the module brightness decrease to 50% original.